

Modular Kennel Cages Assembly Instructions Small and Medium

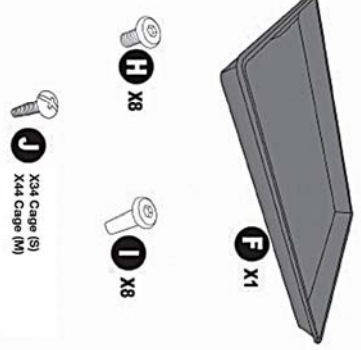

- Parts List**
- (A) Side Panels (2)
 - (B) Back Panel (1)
 - (C) Top/Bottom Panels (2)
 - (D) Front Door (1)
 - (E) Allen Wrenches (2)
 - (F) Tray (1)
 - (G) Floor Grate (1)
 - (H) and (I) Front Door Fasteners (8)
 - (J) Screw for Modular Kennels (34)
 - Screws for Modular Kennels (M) (44)

TIP: For each step, do not completely tighten screws and bolts until all have been fitted to the structure.

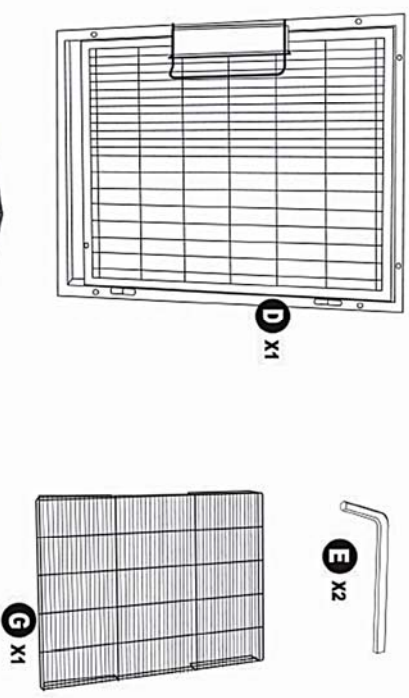
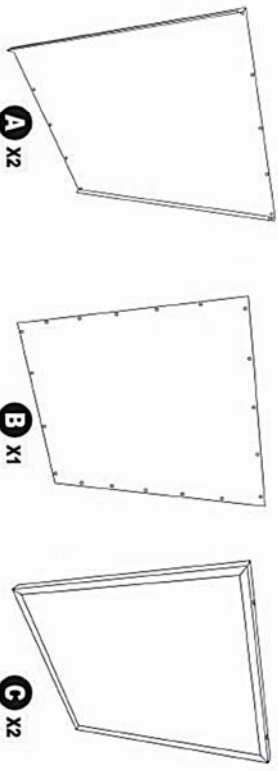
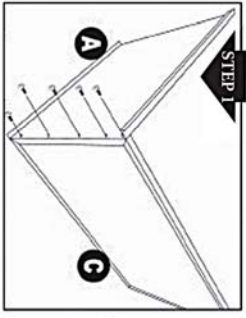

1. Connect Side Panels (A) to Top and Bottom Panels (C) using Screws (J). Note: the panel sides with the metal edging should all be facing out. The flat sides should face in.

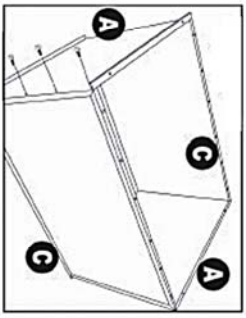

2. Connect the Back Panel (B) to the assembled panels using Screws (J).

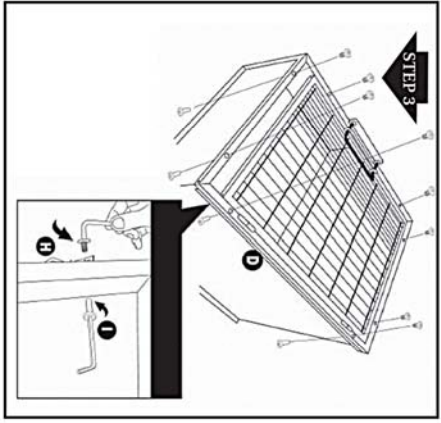

3. Attach the Front Panel (D) to the front of the structure using Bolts (H and I). The smaller (H) bolts should connect from the front, the Larger (I) bolts should connect from the back. Use the two Allen Wrenches (E) as shown to secure bolts during assembly.

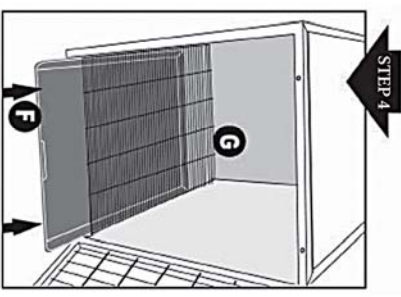

4. Slide the Floor Tray (F) and the Floor Grate (G) into the structure.

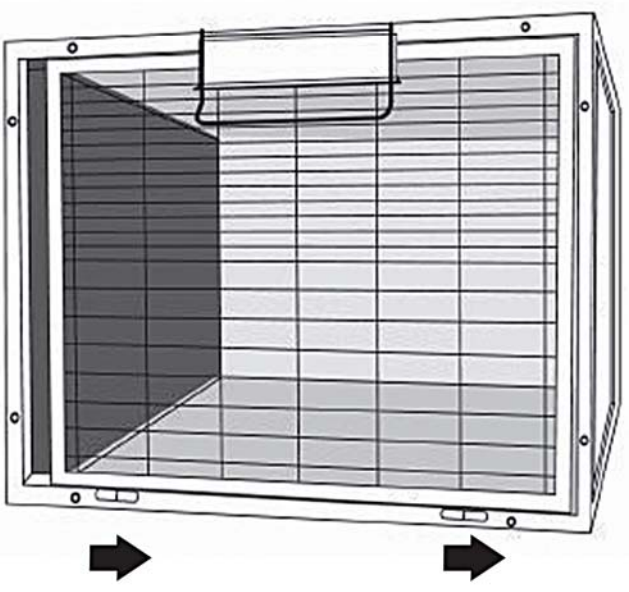

5. The doors can be taken off the hinges by lifting them straight up and off.

3 Unit Modular Kennel Cage Bank Kit

Parts List

- (A) Modular Kennel Cage (L) (1)
- (B) Modular Kennel Cage (M) (2)
- (C) Cage Connectors (20)

(Optional Items Sold Separately)

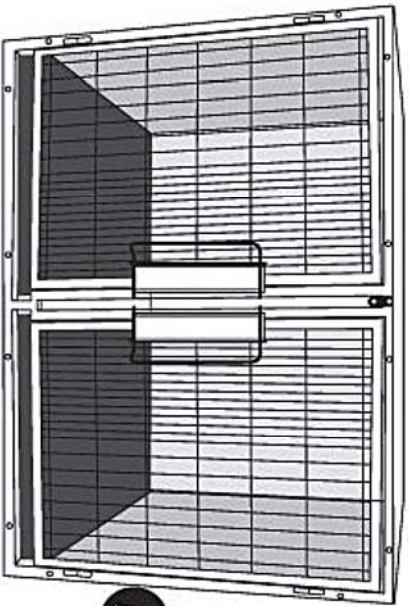

A X1

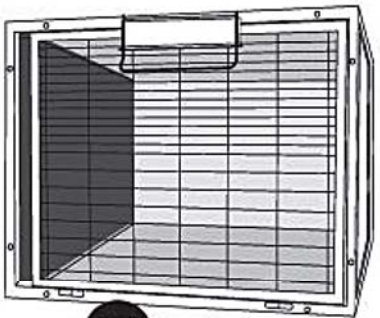

B X2



C X20

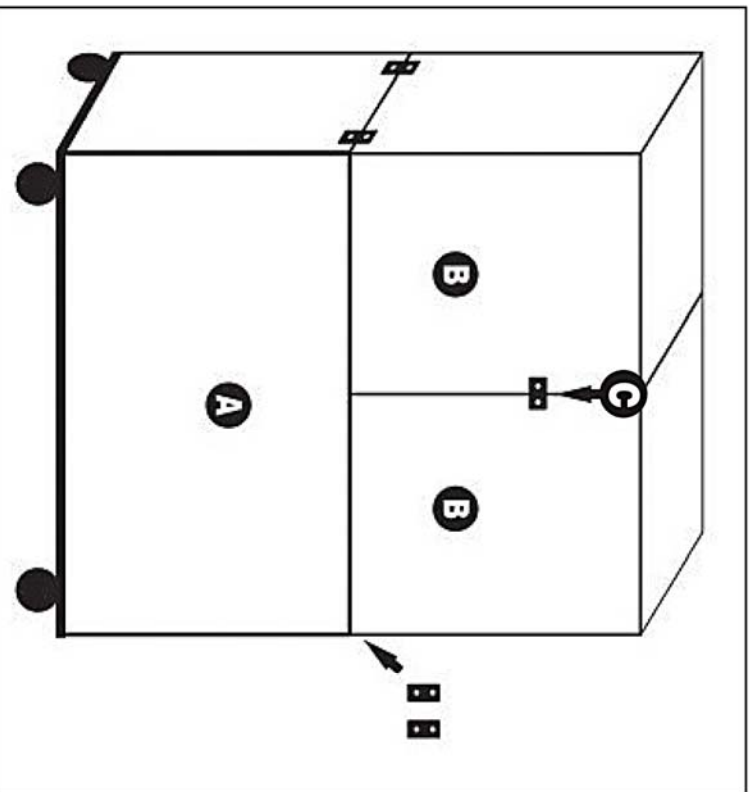

Arrange the two Medium Cages on top of the one Large Cage. Not sold with Cage Base.

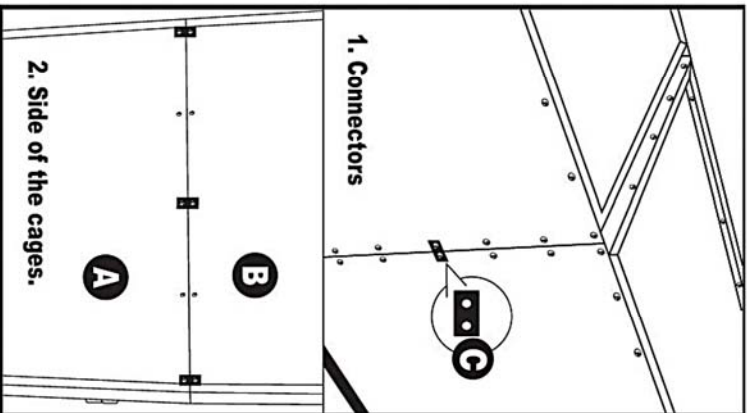

2. Side of the cages.

Cage Connectors are designed to work with your existing cage hardware. Unscrew the bolts at the contact points between two cages. Fit the Connector over the two open holes, then screw in the bolts to secure the Connectors in place. Use at least two Connectors for each touching cage side.

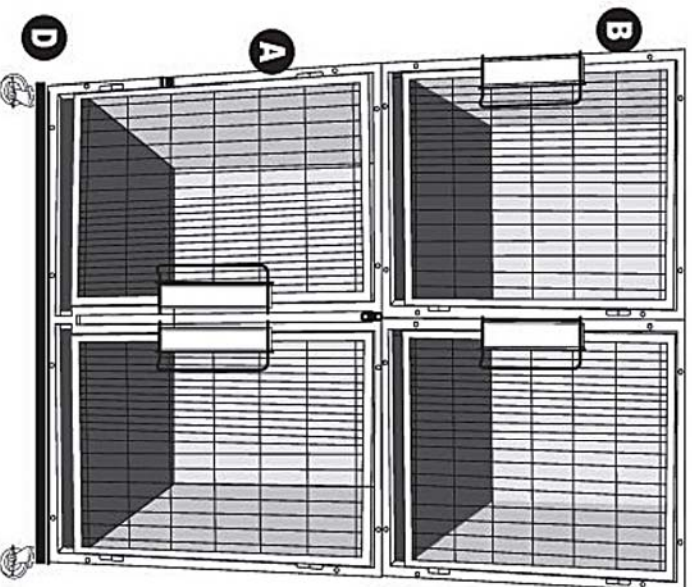

Do not use stacked Cages until they are secured together with Cage Connectors. Shown with optional Small Cage Base (sold separately).

6 Unit Modular Kennel Cage Bank Kit

Parts List

- (A) Modular Kennel Cage (L) (2)
- (B) Modular Kennel Cage (M) (4)
- (C) Cage Connectors (20)

(Optional Items Sold Separately)

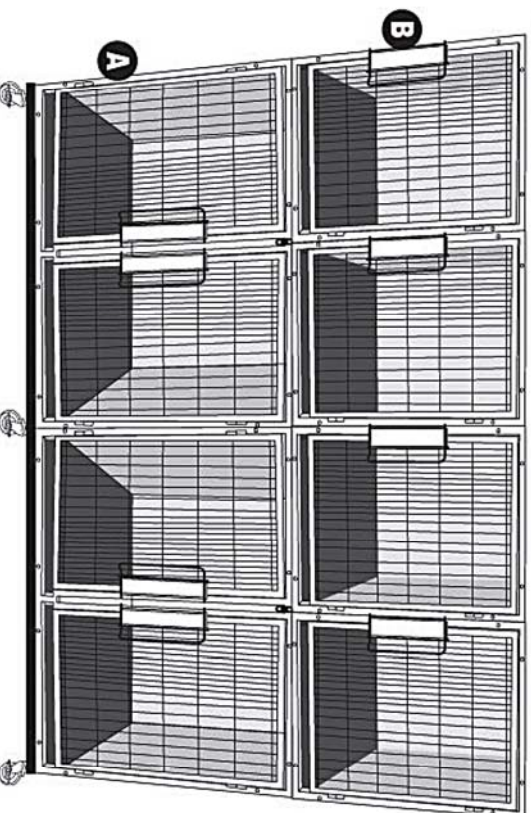
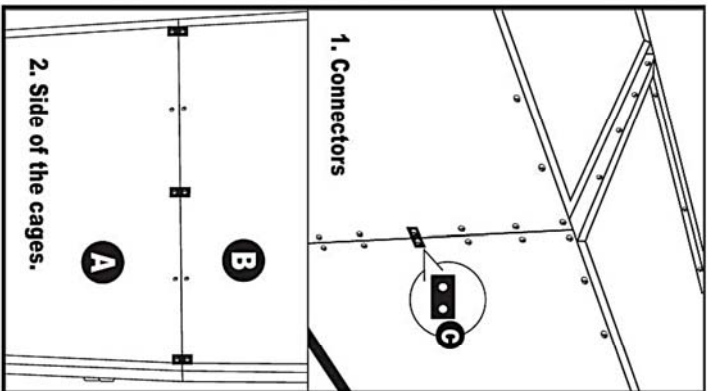
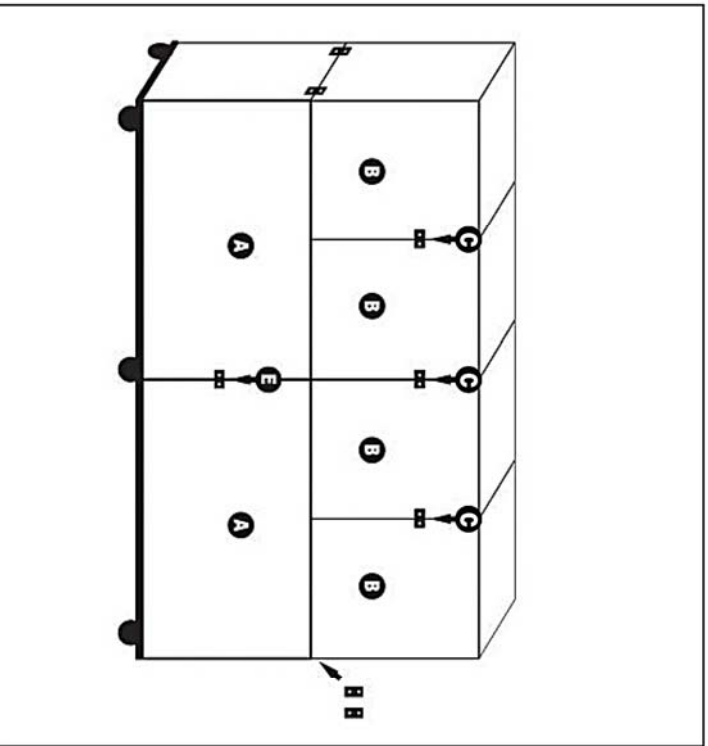
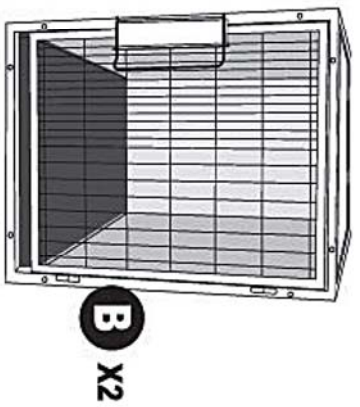
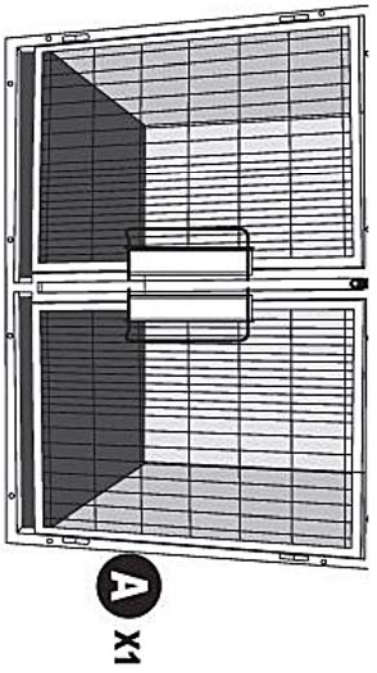

Arrange the four Medium Cages on top of the two Large Cages. Not sold with Cage Base.

Cage Connectors are designed to work with your existing cage hardware. Unscrew the bolts at the contact points between two cages. Fit the Connector over the two open holes, then screw in the bolts to secure the Connectors in place. Use at least two Connectors for each touching cage side.

Do not use stacked Cages until they are secured together with Cage Connectors. Shown with optional Large Cage Base (sold separately).

11 Unit Modular Kennel Cage Bank Kit

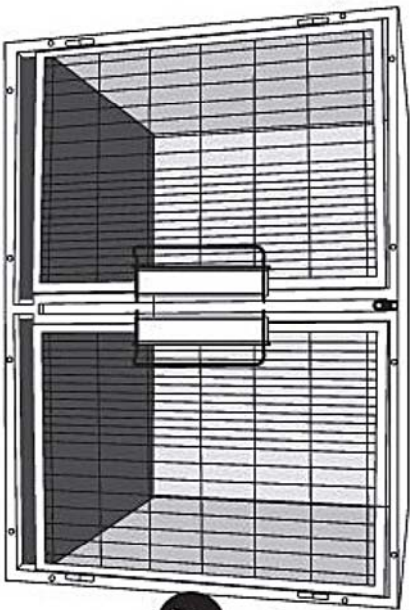

A X2

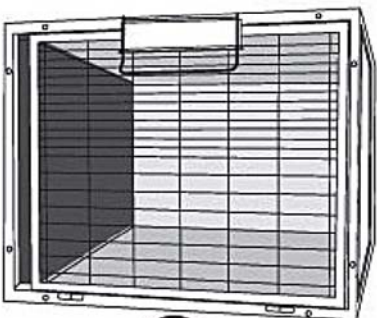

B X4

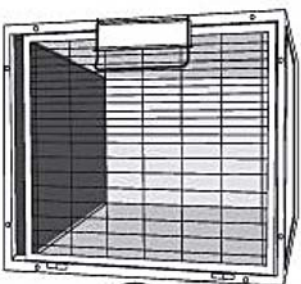

C X5



2 Sets of 20

- Parts List**
- (A) Modular Kennel Cage (L) (2)
 - (B) Modular Kennel Cage (M) (4)
 - (C) Modular Kennel Cage (S) (5)
 - (D) Cage Connectors (20 x 2)

(Optional Items Sold Separately)

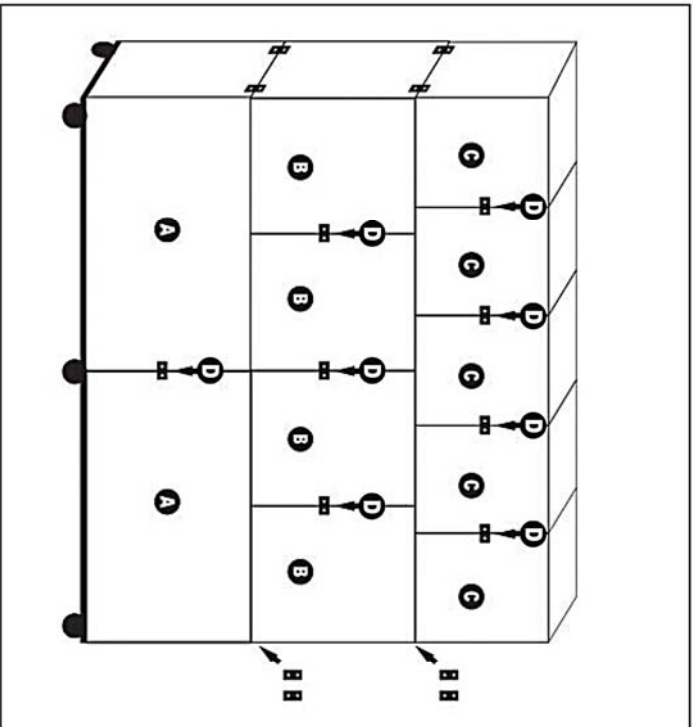

Arrange the five Small cages on the top row, the four Medium Cages on the middle row, and the two Large Cages on the bottom row. Not sold with Cage Base.

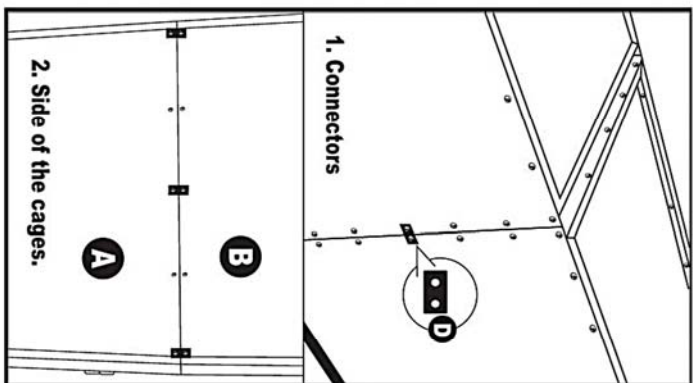

Cage Connectors are designed to work with your existing cage hardware. Unscrew the bolts at the contact points between two cages. Fit the Connector over the two open holes, then screw in the bolts to secure the Connectors in place. Use at least two Connectors for each touching cage side.

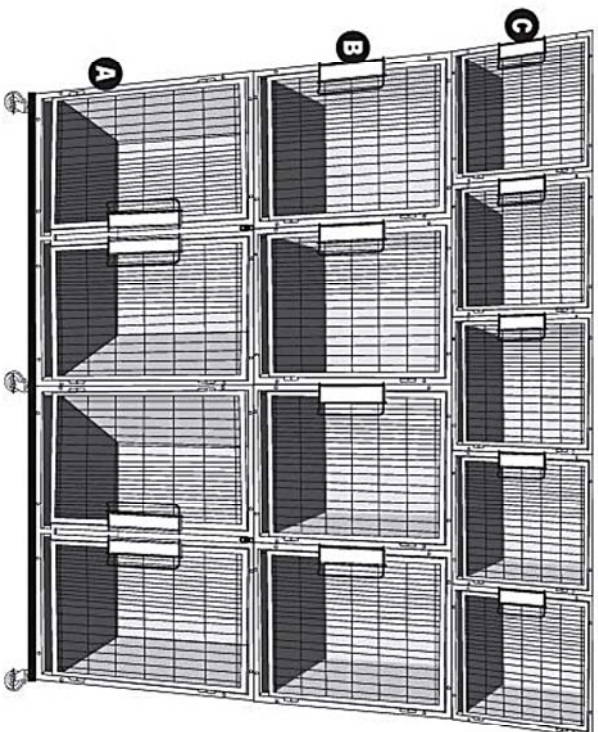

Do not use stacked Cages until they are secured together with Cage Connectors. Shown with optional Large Cage Base (sold separately).

Modular Kennel Cage Assembly Instructions Large

TIP: For each step, do not completely tighten screws and bolts until all have been fitted to the structure.

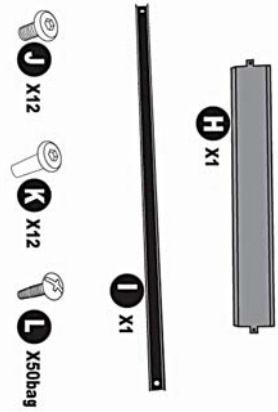
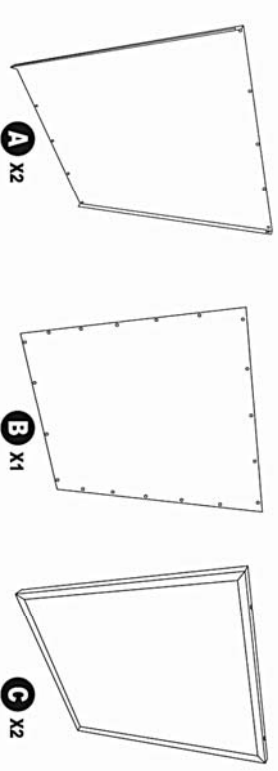

- Parts List**
- (A) Side Panels (2)
 - (B) Back Panel (1)
 - (C) Top/Bottom Panels (2)
 - (D) Front Door (1)
 - (E) Allen Wrenches (2)
 - (F) Tray (1)
 - (G) Floor Grates (1)
 - (H) Floor Grate Connection Panel (1)
 - (I) Divider Panel Holder (1)
 - (J) and (K) Front Door Fasteners (1)
 - (L) Screws (50)

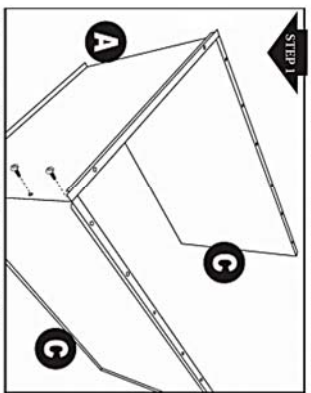

1. Connect the Side Panels (A) to the Top and Bottom Panels (C) using Screws (L). Note: the panel sides with the metal edging should all be facing out. The flat sides should face in.

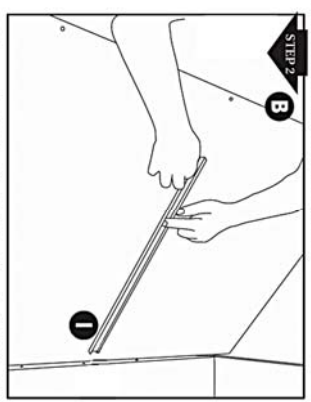

2. Connect the Dividing Panel Holder (I) to the Back Panel (B) using Screws (L). Note: The end where the Dividing Panel Holder (I) is closer to the edge of the Back Panel is the bottom end.

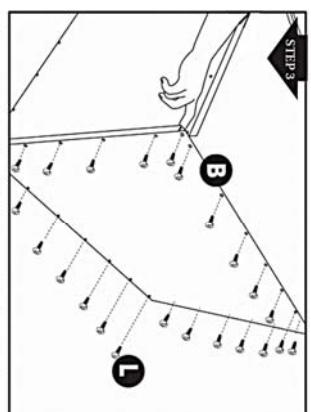

3. Connect the Back Panel (B) to the assembled panels using Screws (L).

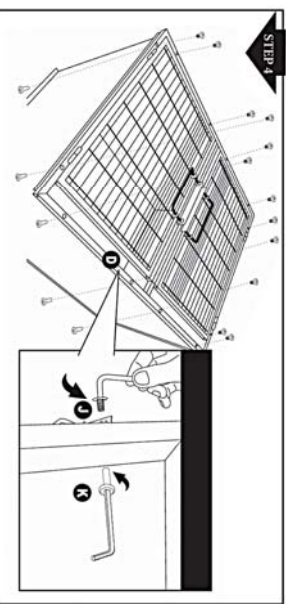

4. Secure the Front Panel (D) to the assembled panels using bolts J and K. The smaller (J) bolts should connect from the front, the Larger (K) bolts from the back. Use the two Allen Wrenches (E) secure the bolts as shown.

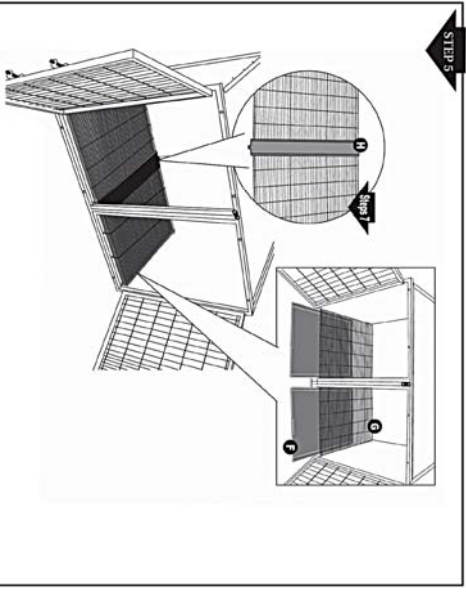
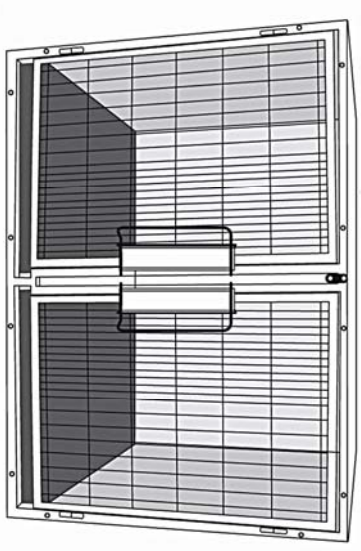

5. Slide the two Floor Grates (F) and Floor Grates (G) into the cage. Place the Floor Grate Connection Panel (H) over the gap between the two Grates. To remove Floor Grates from this cage, lift the Grate up and turn it at an angle. The Grate will slide right out.

7. The doors can be taken off the hinges of the Front Panel by lifting them straight up and off.

8. An optional Divider Panel (sold separately) can be used to separate this large cage into two smaller ones. See PetEdge.com for details.